

## **READ AND SAVE THESE INSTRUCTIONS**

Riviera DC

*Thank you for purchasing a Gulf Coast Fans, Inc. product. It will provide years of cost efficient comfort. With over a decade of experience in ensuring quality workmanship at an affordable price, we stand behind our product and we hope you will too.*

### **IMPORTANT PRECAUTIONS**

- 1** Read these instructions carefully before you start.
- 2** Turn off the power at the source before installation, servicing, or cleaning.
- 3** WARNING--TO REDUCE THE RISK OF FIRE OR ELECTRIC SHOCK, DO NOT USE THIS FAN WITH ANY ADDITIONAL CONTROL DEVICE. USE ONLY THE INCLUDED REMOTE CONTROL WITH THIS FAN.
- 4** WARNING--TO REDUCE THE RISK OF PERSONAL INJURY, DO NOT BEND THE BLADE IRONS WHEN INSTALLING ON BLADES, BALANCING THE BLADES, OR CLEANING THE FAN. DO NOT INSERT FOREIGN OBJECTS IN BETWEEN ROTATING FAN BLADES.
- 5** WARNING--TO REDUCE THE RISK OF FIRE, ELECTRIC SHOCK, OR PERSONAL INJURY, MOUNT FAN TO AN OUTLET BOX MARKED "ACCEPTABLE FOR FAN SUPPORT" AND USE MOUNTING SCREWS PROVIDED WITH THE OUTLET BOX.
- 6** If you don't feel comfortable hanging and wiring this fan, we recommend that you hire a qualified electrician to install it.
- 7** All wiring and electrical connections must meet the National Electrical Code and any local codes that may apply.
- 8** After installation, fan blades must be at least seven (7) feet from the floor.

To begin with, the site of installation must be clear of any obstructions. Walls, cabinet or cupboard doors, and AC/heating vents (strong air currents will cause fan to wobble) are common obstructions.

Also, you will need a securely mounted outlet box that is listed for fan support. You may also mount fan directly to a ceiling joist, but you must use a Ceiling Fan Swag Kit to provide power.

The only tools you will need are: A medium Phillips screwdriver, common sense, and a little caution.

I. Inventory the parts. Remove all of the parts from the top styrofoam and remove the styrofoam. Use this top piece to support the fan during preliminary assembly.

A. Remove all parts from plastic bags, including the screw package.

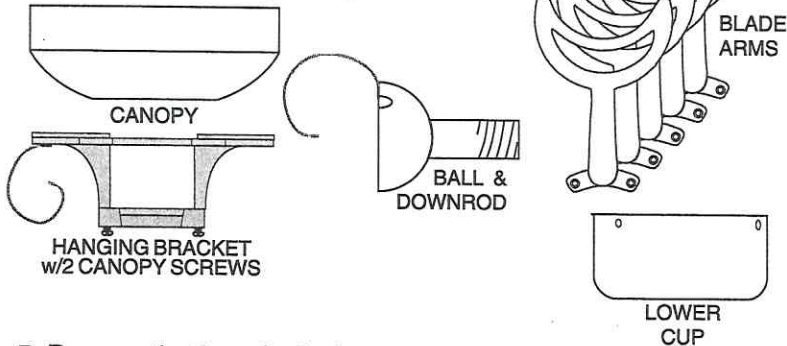

B. Remove the three (to five) screws with the black shipping blocks from the face of the motor and discard.



C. Remove the three (3) 1/8"-32x1/4" screws from the switch cup plate on motor assembly.



D. Place the motor, switch cup plate down, in top styrofoam. Remove the 1/4"-20x1 3/16" threaded pin from coupler and loosen set screw so its tip does not interfere with the threads within the coupler.

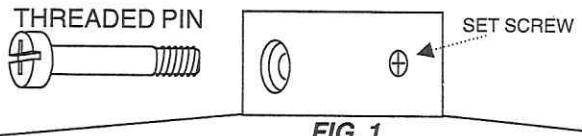
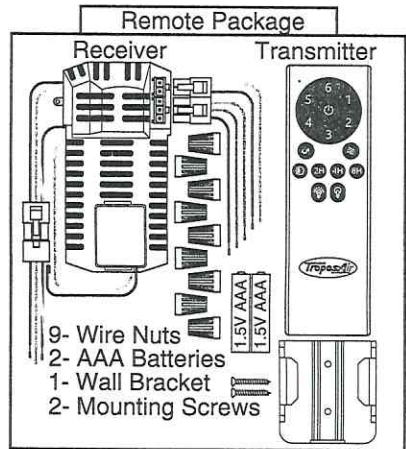
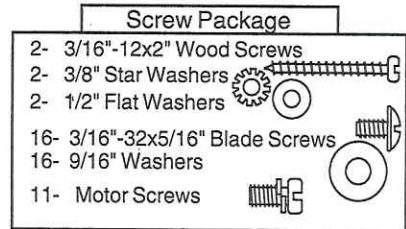

FIG. 1



II. Preliminary Assembly.

A.1. Take the ball & downrod and loosen the set screw in the ball. Remove the pin and the ball from the downrod. (If you have a longer downrod, use it now.) See Fig. 2

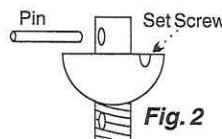

Fig. 2

2. Feed the three wires from the top of the fan through the downrod and thread the downrod into the coupler. Align the holes in the downrod with the holes in the coupler. See Fig. 3

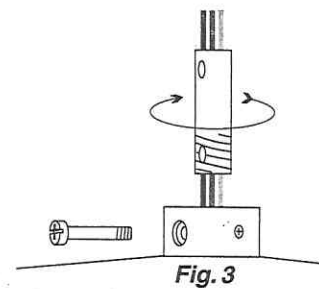

Fig. 3

3. Insert the threaded pin and tighten it and the set screw.

4. Place the canopy around the downrod. Slide the ball onto the downrod and replace pin. See Fig. 4

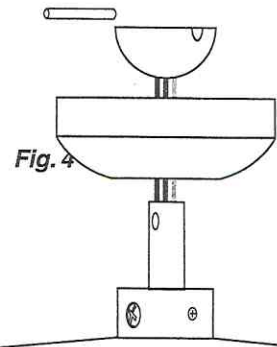

Fig. 4

5. Raise the ball so that the pin is in the slot and tighten the set screw. See Fig. 5

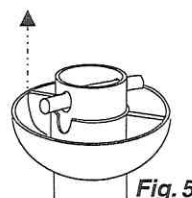
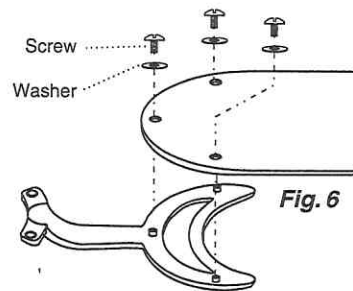

Fig. 5

6. Make sure all of the screws are tight. At this time you may want to shorten the wires from the fan to 6" from the ball. This helps when you tuck the wires into outlet box.

II. Preliminary Assembly.  
cont.

B. Snap together blade and blade iron. Note the side of the blade you want to show. Using the 3/16"-32x5/16" blade screws and 9/16" washers, three of each per blade, secure blade to blade iron. Repeat this procedure with the rest of the blades. You will have at least one screw and one washer left over, these are spares. Be sure all of the screws are tight. Fig. 6



**WARNING - To Reduce The Risk Of Fire, Electric Shock, Or Personal Injury Mount Fan To Outlet Box Marked Acceptable For Fan Support And Use The Mounting Screws Provided With The Outlet Box**

1. Take the hanging bracket and secure it to the outlet box (marked Acceptable For Fan Support) using the mounting screws provided with the outlet box, Fig 7 below. Tighten them evenly.

2. Remove one canopy screw (also Fig 7) and loosen the other. Make sure all of the wires are accessible and are not being pinched. Also, make sure the bracket doesn't wobble.

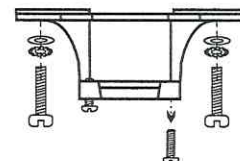

III. Hanging the fan motor

Holding the fan carefully, lift it up to hanging bracket. Place the ball into cradle of the bracket. Turn the entire motor assembly until it locks into place. The tab on the bracket must be in the groove in the ball. Make sure the wires are not being pinched.

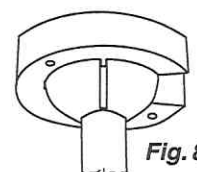

IV. Wiring connections

1. Insert receiver into mounting bracket

Note: Do not squeeze all the wires while inserting the receiver into the mounting bracket.

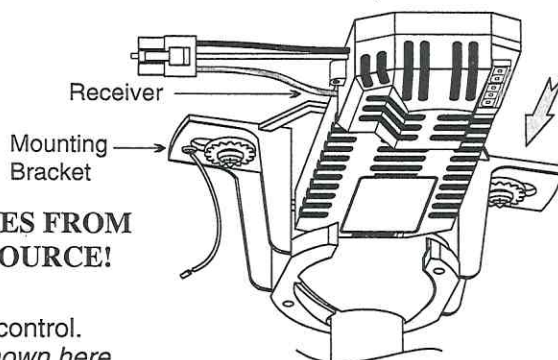

**IMPORTANT: DO NOT CONNECT WIRES FROM FAN MOTOR DIRECTLY TO POWER SOURCE!**

2. Making electrical wire connections

Detailed instructions are enclosed with the remote control.

For convenience, basic wiring connections are shown here

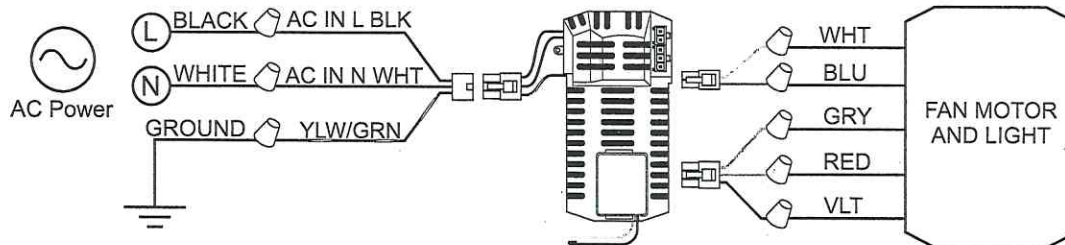

Now tuck the wires and wirenuts carefully into outlet box. Make sure wirenuts remain tightly on connections.

V. With the motor and remote receiver in place and the wires out of the way, slide the canopy up to the hanging bracket. The canopy screw in the bracket will come through the large end of the key slot in the canopy. Fig. 12. Turn the canopy slightly, counter-clockwise, to hold in place, and insert remaining canopy screw. Tighten the screws.

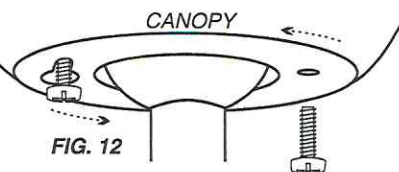

VI. To avoid damaging the motor, do not run the fan without blades. So, the next step is to mount the blade assemblies on the motor. The easiest way to do this is to insert a motor screw into one hole on the base of the blade iron; hold it in place with a screwdriver and lift blade assembly into place. Fig. 13. Start this screw in an appropriate hole in motor. Now insert another into the other hole and tighten both screws. Repeat this with the rest of the blade assemblies, and retighten all of the screws.

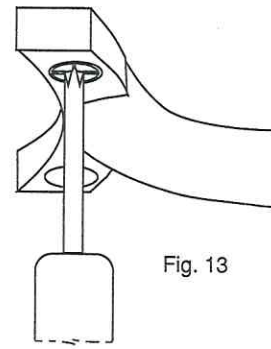

Fig. 13

VII. You're just about done now. The lower cup is the last step, and it's simple. If you are attaching a light kit, follow the light kit instructions now, then treat the light kit/lower cup assembly as one piece. Lift the cup into place. Insert one of the screws removed earlier and thread into the lower plate. Insert the remaining cup screws and tighten all. Fig. 14.

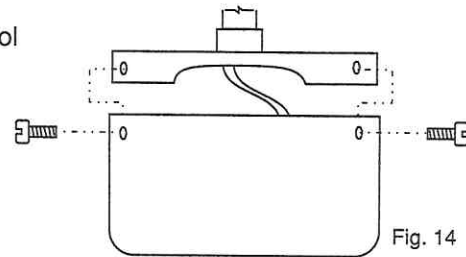

Fig. 14

VIII. Turn the power supply back on and refer to the Remote Control Instructions to complete the pairing process.

**NOTE: REVERSING DIRECTION WILL CAUSE THE FAN TO STOP BEFORE REVERSING.**

IX. Troubleshooting	
Fan won't run -	Check power supply. Pin is pushed out of a remote receiver wire connector
Fan makes noise -	Please allow 24 hrs. running time to fully seat bearings. Loose screw(s) somewhere, especially in the hanging system. Ball is not seated properly in hanging bracket.
Fan wobbles -	Bracket is loose on ceiling. Loose screw(s) at hanging system. Ball is not seated properly in hanging bracket. Try switching opposing blades. Try the blade balancing kit included.

We recommend that you retighten the screws after fan has been up for 30 to 60 days. This should include all blade screws and all jam screws secured against the downrod.

Gulf Coast Fans, Inc. products are sold at Dan's Fan City stores.

Our service department is always ready to help. We stand behind our product and always strive to satisfy our customer.

Gulf Coast Fans, Inc.  
300 Dunbar Avenue  
Oldsmar, Florida 34677  
(813)-855-7384

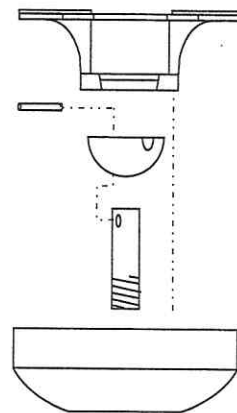

Complete Assembly Breakdown Fig. 16

